

Installation Instructions

LAMP®

SAS-V

CONCEALED DOOR RESTRICTOR Angle Adjustable

Dimensions are based on millimeters; inch values are approximate and for reference only.

Product Info

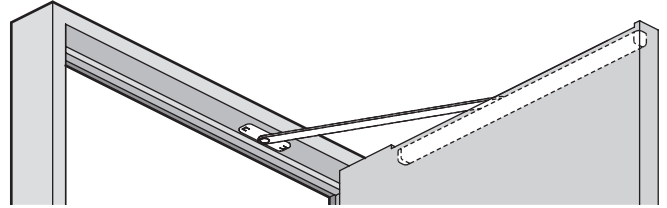

ABOUT THE PRODUCT

- For indoor use. Mounts flush into the top of the door.
- The door's opening angle is adjustable up to 110°.

SPECIFICATIONS

Item Name	Hold (Keep Open)	Max. Opening Angle	Door Width mm [inch]	Door Thickness mm [inch]	Door Weight
SAS-V450	-	Max. 110°	580-900 [22-27/32" - 35-7/16"]	30-50 [1-3/16"-1-31/32"]	Max. 50kg 110.2 lbs
SAS-V600	-		800-1100 [31-1/2" - 43-5/16"]		
SAS-V450H	✓	580-900 [22-27/32" - 35-7/16"]			
SAS-V600H		800-1100 [31-1/2" - 43-5/16"]			

FOR YOUR SAFETY AND CORRECT INSTALLATION

- ⚠ Caution ⚠ Required ⚡ Prohibited

⚠ Caution Not following these instructions can cause injury or damage.

- Follow the specified dimensions and installation requirements, and ensure that all parts are level and vertical. Warping, tilting, or twisting of the frame or door may cause malfunction.
- This product is intended for architectural doors. After installation, check that the door operates safely as a finished assembly.
- Use a frame strong enough to support the door's weight and withstand the impact during opening and closing.
- Use only the specified screws and tighten them securely.
- Regularly check that the mounting screws are not loose. If any looseness is found, tighten them securely.
- Do not attempt to force the door open beyond its fully open position or use the product as a stopper against wind pressure.
- Do not use in a manner different from the original purpose or on doors other than those specified in this manual.
- Do not touch the sliding arm during door operation.

CUT OUT DIMENSIONS

Unit: mm [inch]

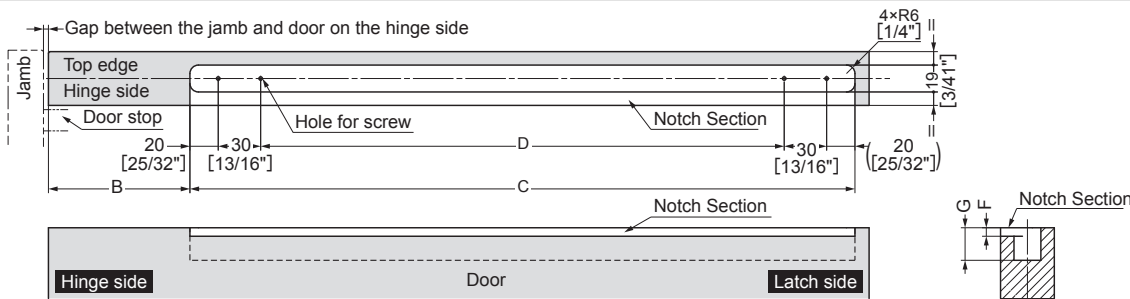

Compatible Hinge (Sold Separately)	Door Damper (Sold Separately)	Item Name SAS-V	Door Width	A	B	C	D
HES2S-140-A125	Not used	SAS-V450	580-900 [22-27/32" - 35-7/16"]	180 [7-3/32"]	100 [3-15/16"]	470 [18-1/2"]	370 [14-9/16"]
		SAS-V600	800-900 [31-1/2" - 35-7/16"]	240 [9-7/16"]	170 [6-11/16"]	620 [24-13/32"]	520 [20-15/16"]
HES2S-150-A110	LDD-K	SAS-V450	700-900 [27-9/16" - 35-7/16"]	180 [7-3/32"]	100 [3-15/16"]	470 [18-1/2"]	370 [14-9/16"]
HES3D-120-A100		LDD-S	850-900 [33-15/32" - 35-7/16"]	290 [11-13/32"]	220 [8-21/32"]	620 [24-13/32"]	520 [20-15/16"]
HES3D-H120-36		LDD-V	Please view the web through the 2D code.				

※ Single-axis hinges (such as butt hinges or flag hinges) can also be used.

INSTALLATION DIAGRAM

Unit: mm [inch]

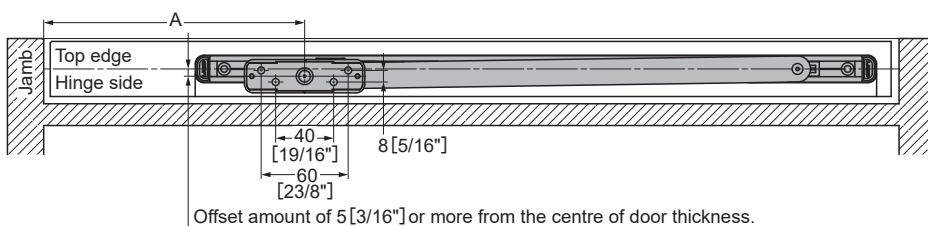

Upper Gap Dimension E ^{※1}	3	4	5	6	7	8	9
Notch Dimension F	6 [1/4"]	5 [3/16"]	4 [5/32"]	3 [1/8"]	2 [3/32"]	1 [1/32"]	0 [0"]
Recessed Dimensions G	23 [29/32"]	22 [7/8"]	21 [13/16"]	20 [25/32"]	19 [3/4"]	18 [23/32"]	17 [21/32"]

※1 Minor door sag of up to 5 mm after installation will not affect product performance.

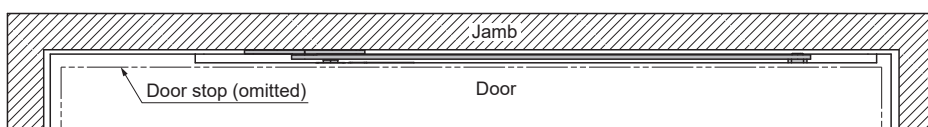

PARTS LIST

Suitable for both left and right-hand doors.

Item Name	Parts	Quantity
① Guide Rail		1
② Arm		1
③ Counter Plate Cover		2

Item Name	Parts	Quantity
④ End Cap		2
⑤ Non-Hold Open Type	+ ※ ²	1
⑤ Hold-Open Type	+ ※ ²	

Item Name	Parts	Quantity
⑥ CSK(Countersunk) Tapping Screw 4x25		8

※²Ensure this component is used during Step ① of the installation.

INSTALLATION

Right-hand opening shown. Left-hand opening is symmetrical.

① Product Assembly

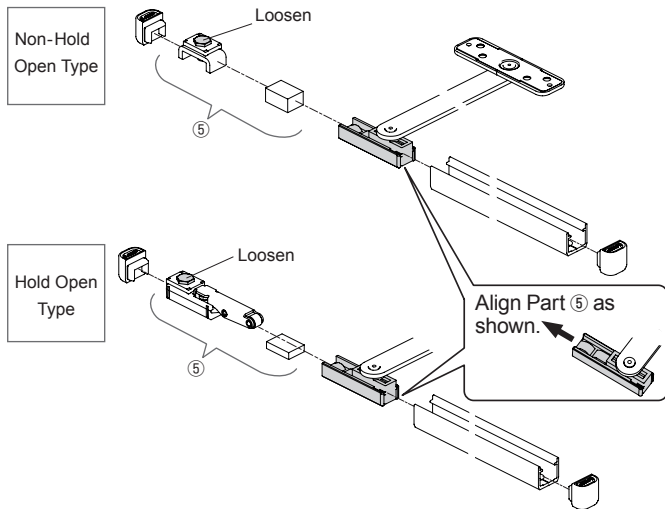

② Attachment to the door

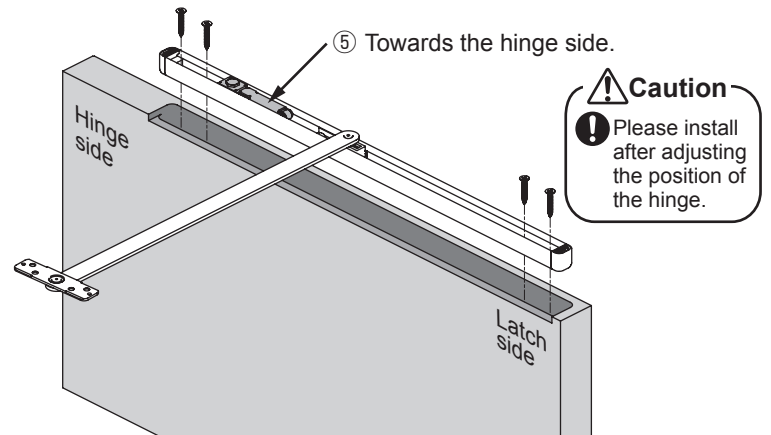

Wooden Doors : CSK Tapping Screw 4x25 (Included)
Metal Doors : CSK Machine Screw M4 (Not included)

③ Mounting to the Head Jamb

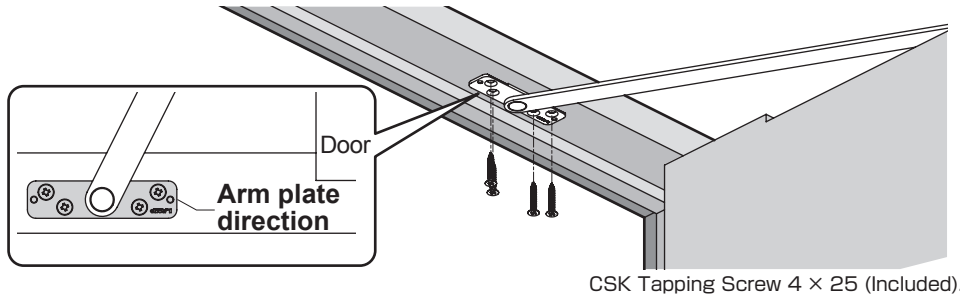

⑤ Installation of Counter Plate Cover

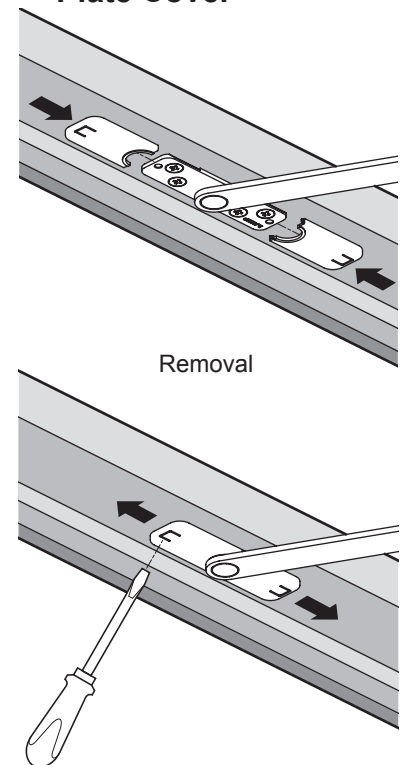

④ Adjustment of Opening Angle

